

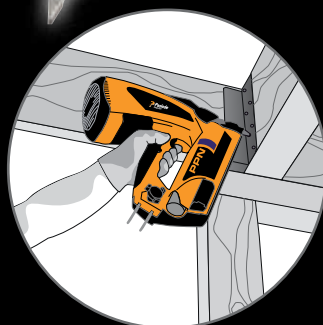

**Paslode**<sup>®</sup>  
Impulse<sup>®</sup>

# PPN35Ci - PPN50Ci





**Paslode**  
Impulse



= 1250  
(-5°C)



**Paslode**  
Impulse



**PPN35Ci**  
Ø 3.4 mm  
L = 35 mm  
Hardened Twisted Nails

**PPN50Ci**  
Ø 4 mm  
L = 35 - 40 - 50 mm  
Hardened Ring Nails



**Paslode**  
Impulse



= 13000 max



15 mn = 2500 max  
60 mn = 10000 max  
90 mn = 13000 max  
2 mn = 200

○ ○ ○ ● 100%  
○ ○ ● 75%  
○ ● 50%  
● 25%

● 0 → 300



# BANG !

- 15 °C → + 49 °C

1000/hour  
3300/day

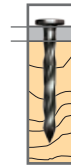

MAX 2 mm

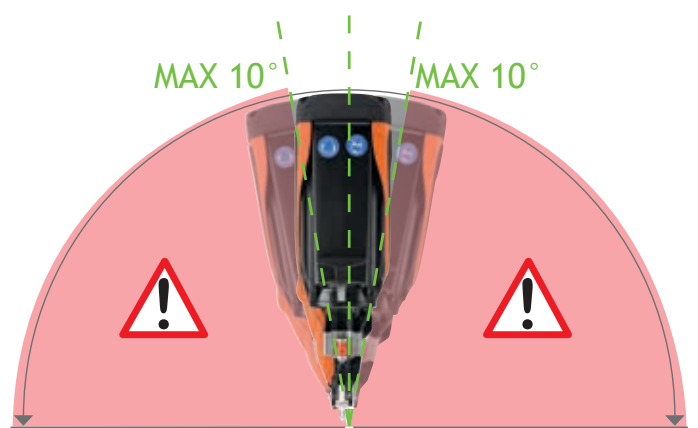
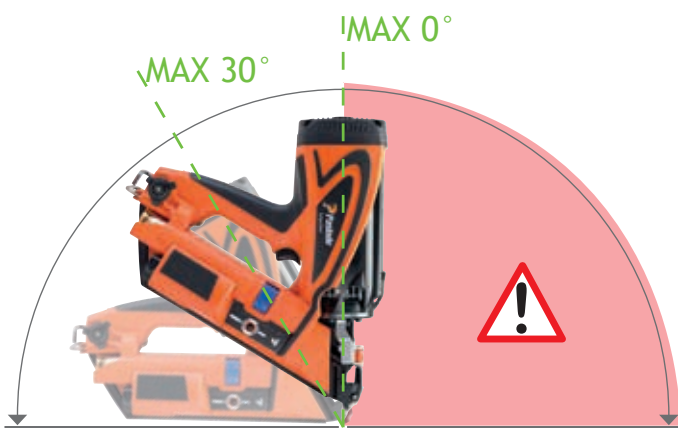
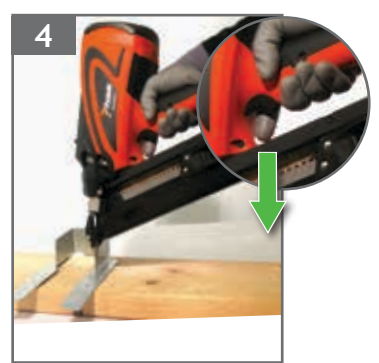
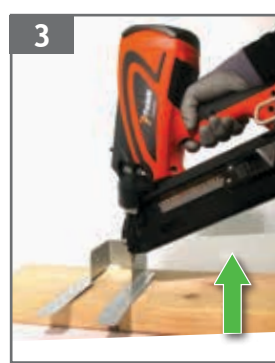
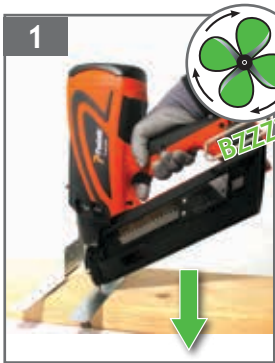

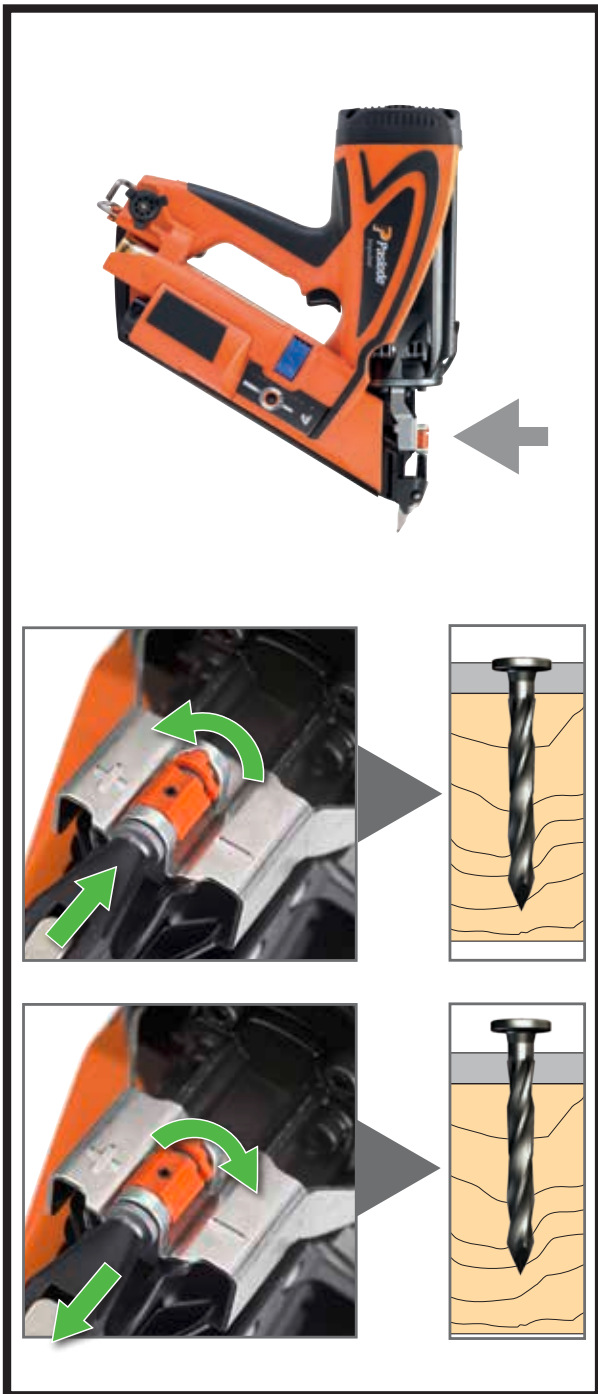

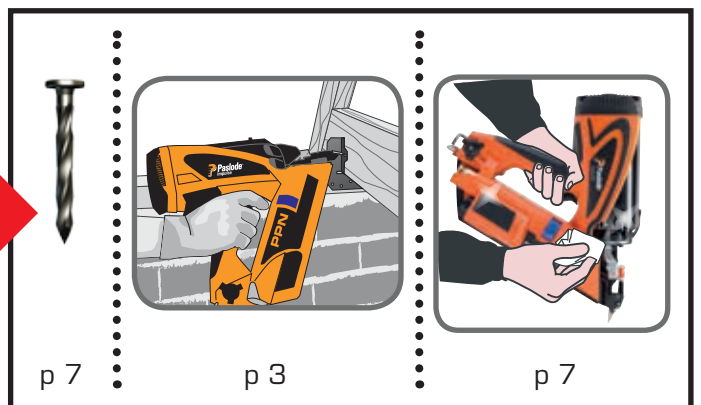
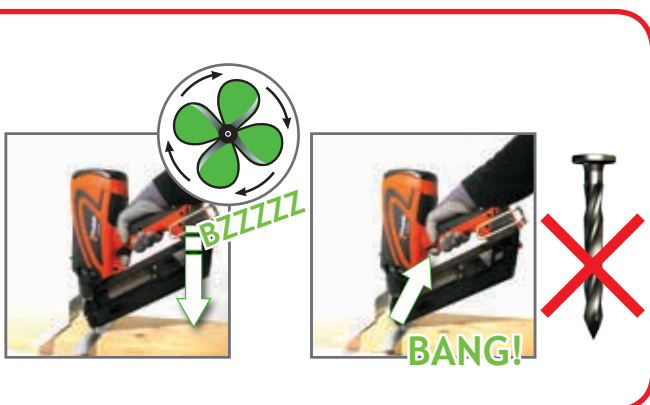
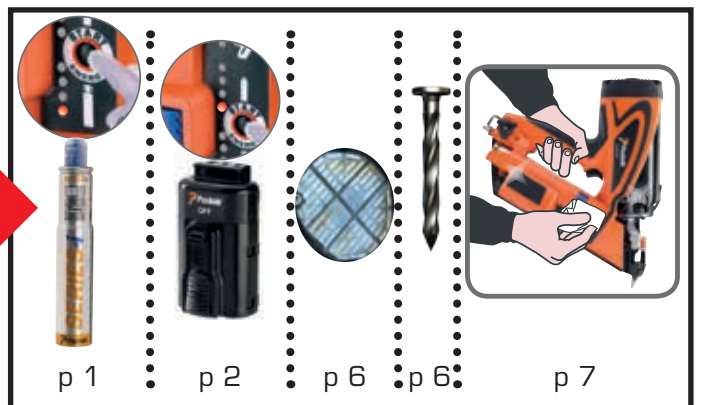
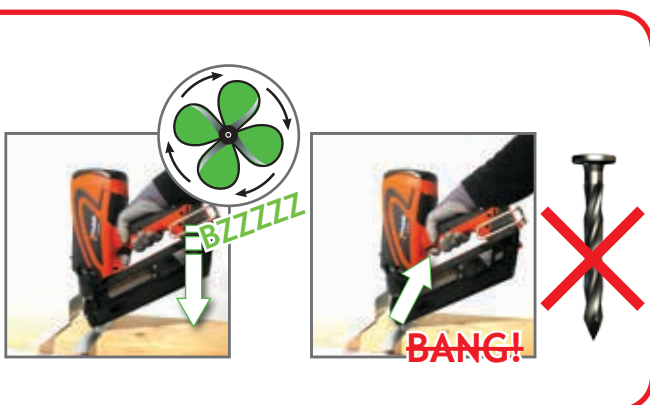
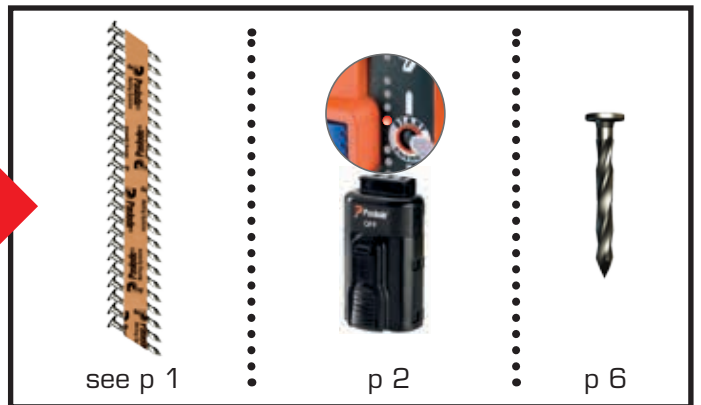
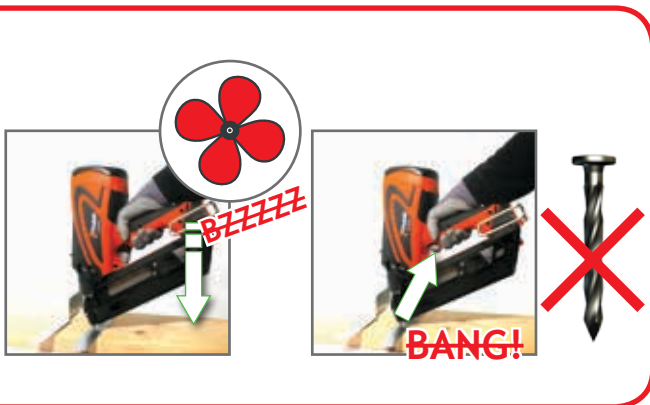
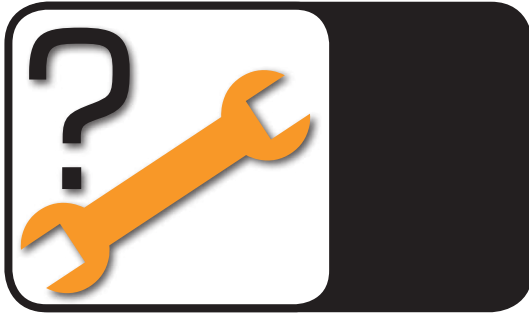

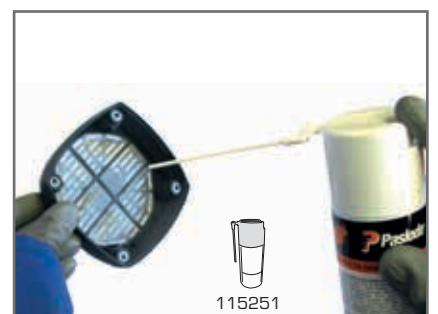
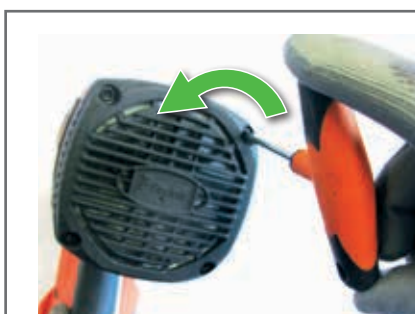
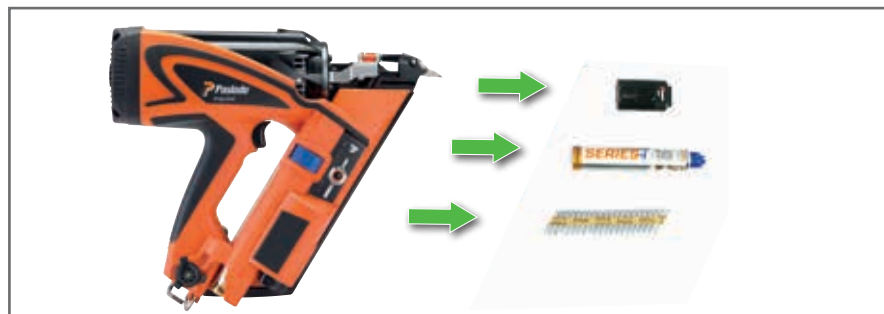
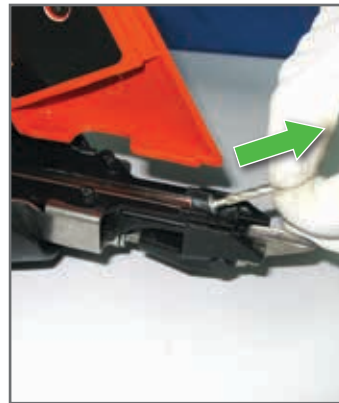
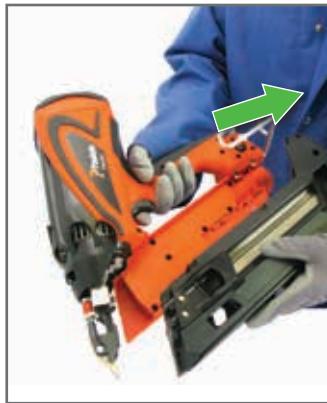
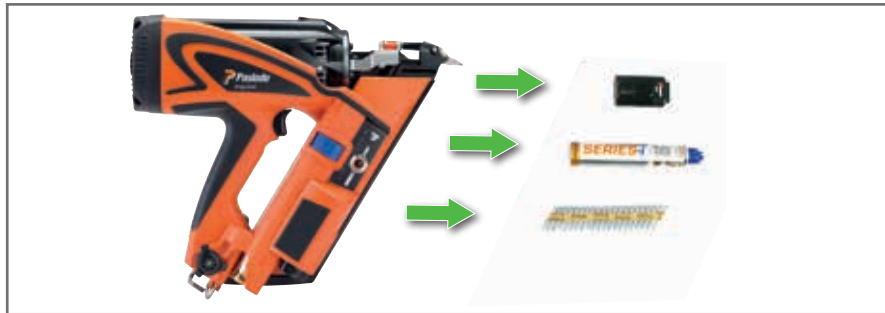

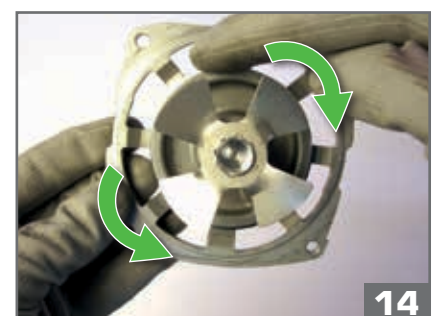
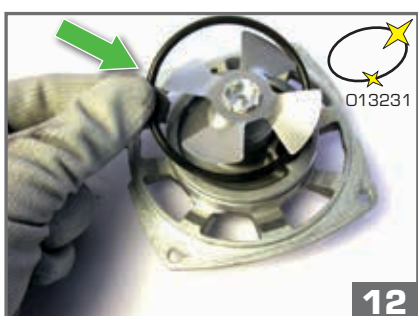
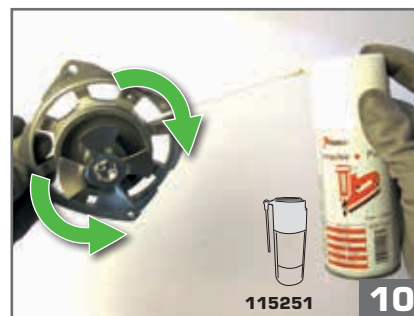
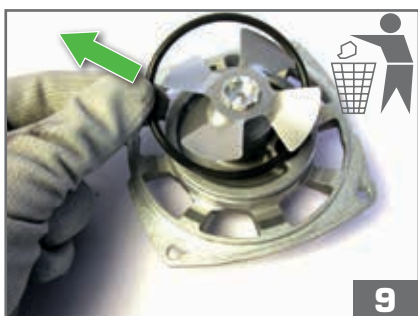
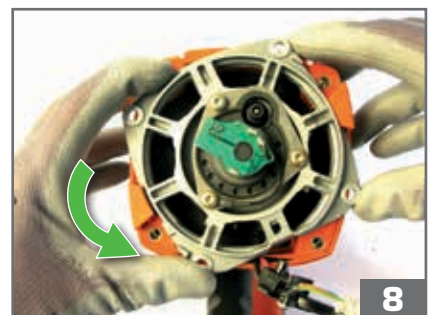
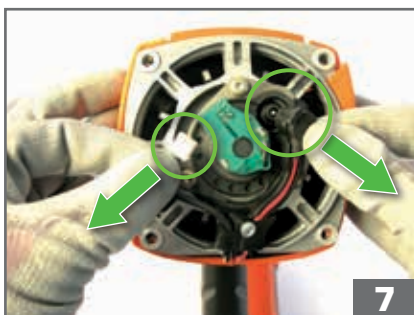
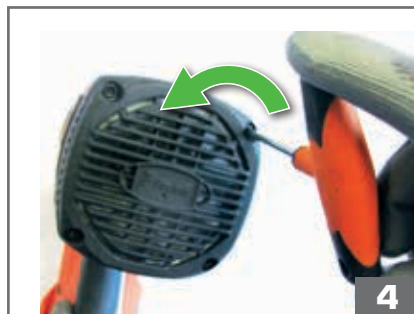
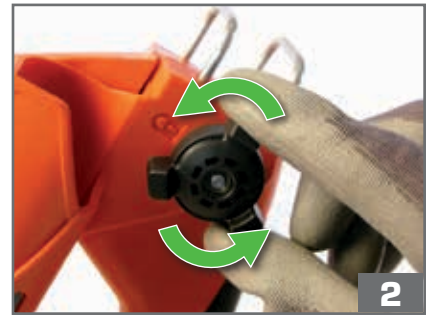
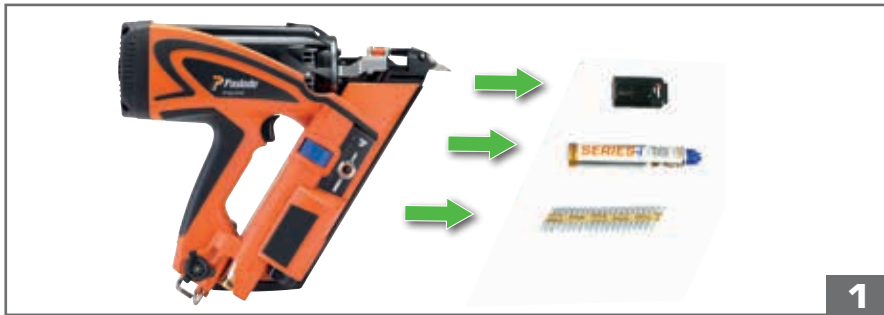
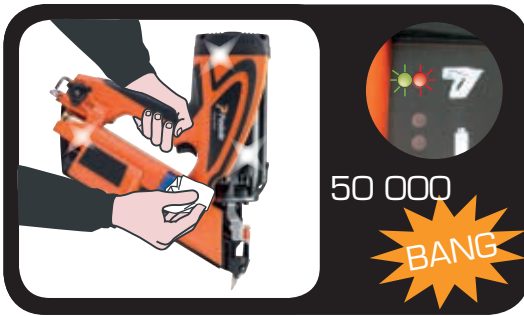



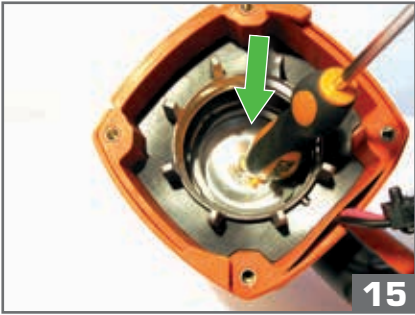

15



115251

16

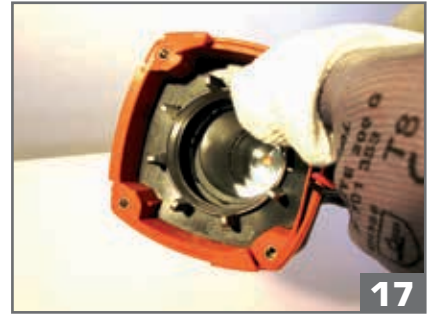

17



401482

18



19

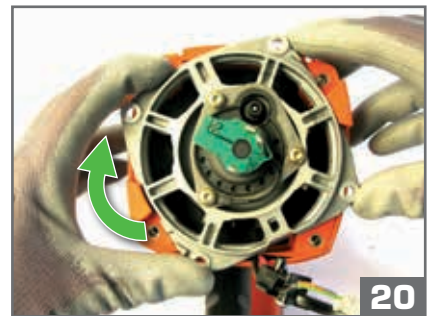

20

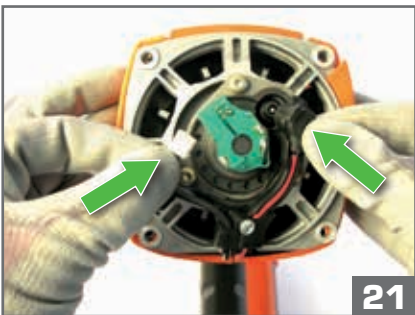

21

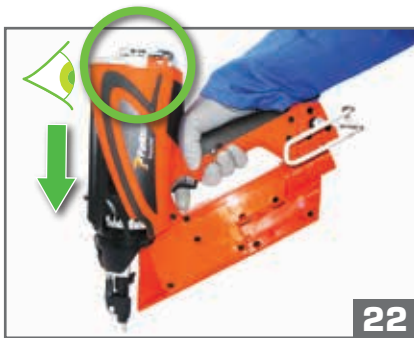

22



OK



NO

24



25

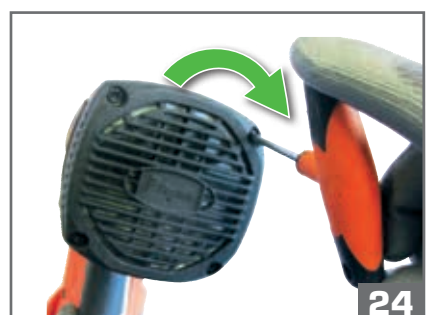

26

RESET



**Notes**



# Notes

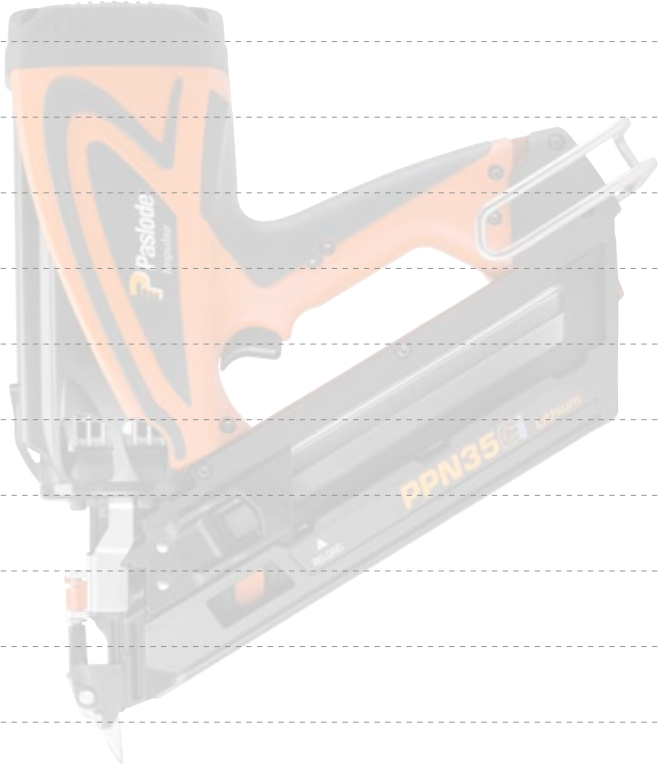



Route de Lyon - BP 104  
F-26501 Bourg-lès-Valence  
Cedex - FRANCE

Réalisation Made in France - Photos non contractuelles



018185-2  
09/15